



2 μ A Ultra Low IQ 1.3A Synchronous Boost IC

DESCRIPTION

The CS5010S is a high efficiency synchronous step-up converter with ultra-low quiescent current down to 2 μ A. It is capable of delivering at least 3W of power from a low voltage source, i.e. 0.7A at 5V output. It also features a ture-shutoff function that disconnects the input from output, during shutdown and output short-circuit conditions. This eliminates the need for an external MOSFET and its control circuitry to disconnect the input from output and provides robust overload protection. A switching frequency of 500KHz minimizes solution footprint by allowing the use of tiny and low profile inductors and ceramic capacitors. An internal synchronous MOSFET provides highest efficiency and with a current mode control that is internally compensated, external parts count is reduced to minimal. With the ultra-low IQ feature, CS5010S is ideal for solution that requires low standby power and compact board size such as IoT applications.

FEATURES

- Ultra low IQ when No Switching: 2 μ A
- Output Disconnect
- Short-circuit Protection
- 5V/0.7A Output Power
- Output to input Reversed Current Protection
- Up to 94% Efficiency
- Internal Synchronous Rectifier
- Current Mode control
- Logic Control Shutdown and Thermal shutdown
- SOT23-6L Package

Package

- SOT23_6L

APPLICATIONS

- TWS
- Tablet MID
- Smart phone
- Power Bank

TYPICAL APPLICATION CIRCUIT

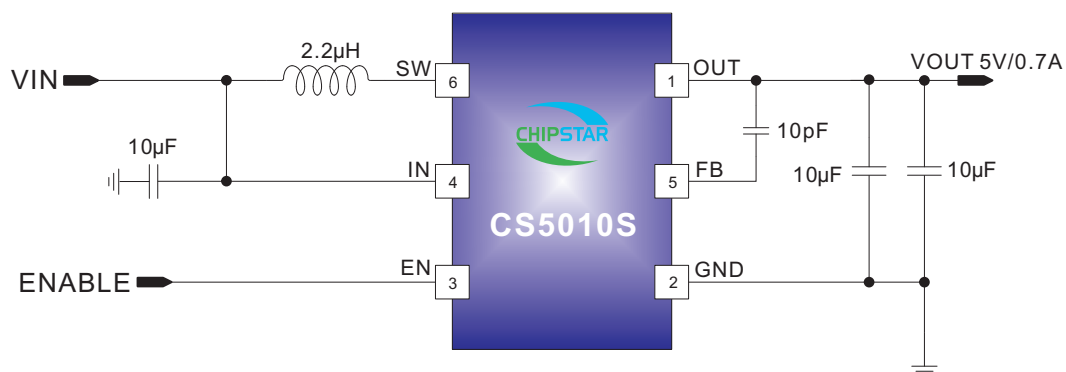

NOTES: Fixed output voltage, 3.3V and 5V. Or setting output voltage thru FB pin with resistors costing extra 7 μ A current.

PIN CONFIGURATION (TOP VIEW)

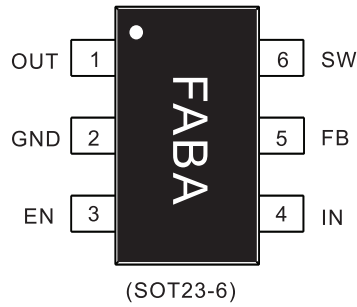

TERMINAL FUNCTIONS

TERMINAL		I/O	DESCRIPTION
NAME	PIN		
OUT	1	O	Output pin. Bypass with a 10µF or larger ceramic capacitor closely between this pin and GND
GND	2	-	Ground Pin
EN	3	I	Enable pin for the IC. Drive this pin high to enable the part, low to disable.
IN	4	I	Input Supply Voltage. Bypass with a 10µF ceramic capacitor to GND
FB	5	I	Feedback Input. Connect a 10pF from OUT to FB pin for fixed output voltage. And add an external resistor divider from the OUT to FB and GND to set VOUT for adjustable output voltage
SW	6	O	Inductor Connection. Connect an inductor Between SW and the regulator output

Block Diagram

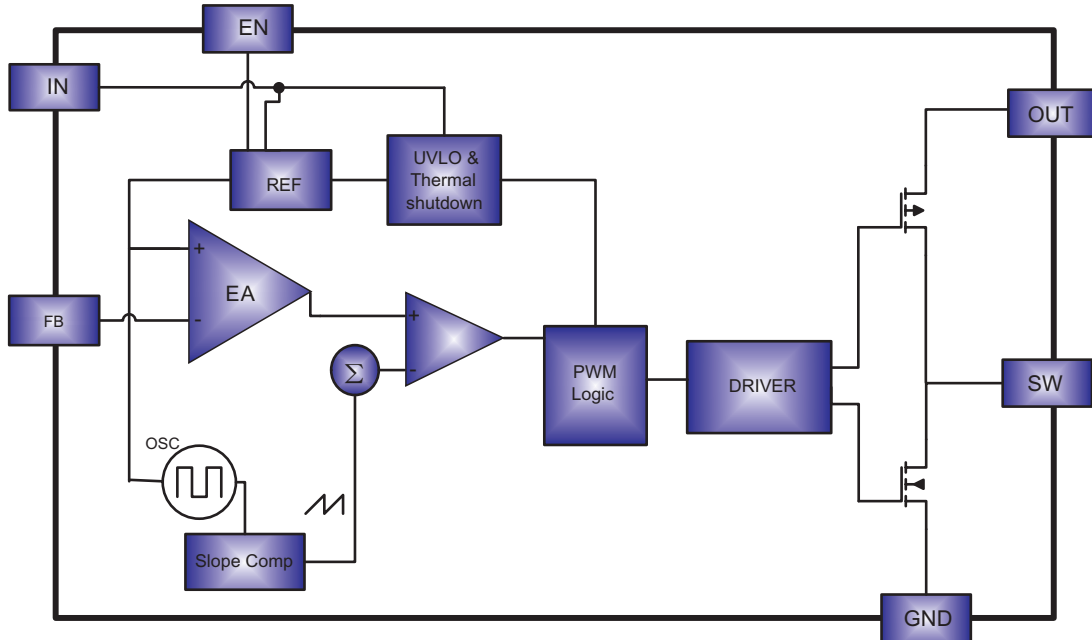

CS5010S

Absolute Maximum Ratings

IN,OUT,SW,FB, EN Voltage	-----	-0.3V to 6.0V
SW to ground current	-----	Internally limited
θ_{JA}	-----	180°C/W
θ_{JC}	-----	90°C/W
Mayction Temperature Range	-----	125°C
Lead Temperature (Soldering, 10 sec.)	-----	260°C
Storage Temperature Range	-----	-55°C to 150°C
Mayction Temperature Range	-----	-40°C to 125°C
Ambient Temperature Range	-----	-40°C to 85°C
ESD HBM(Human Body Mode)	-----	4KV
ESD MM(Machine Mode)	-----	400V

Order Information

Device	Package	Making	Reel Size	Tape Width	Quantity
CS5010S	SOT23-6L		7"	8mm	3000

Electrical Characteristics

($V_{IN}=3.6V$, $V_{OUT} = 5V$, $T_A=25^\circ C$ unless otherwise specified)

PARAMETER	CONDITIONS	MIN	TYP	MAX	UNITS
Quiescent current at OUT	$V_{EN}=IN$, No load , Not Switching		2.0		μA
Shutdown Supply Current at IN	$V_{EN}=GND$		0.1		μA
IN Startup Voltage	$I_{OUT}=1mA$		1.8		V
IN Operation voltage	After Start-up	1.5		4.5	V
Output Voltage t 5V		4.90	5.05	5.20	V
Output Voltage t 3.3V		3.2	3.3	3.4	V
Fedback Voltage		0.985	1.01	1.03	V
Switching Frequency			500		Khz
MOS Swtch On Resistance	$I_{SW}=100mA$		220		m Ω
PMOS Switch On Resistance	$I_{SW}=100mA$		160		m Ω
SW Leakage Current	$V_{OUT}=5.2V, V_{EN}=GND, V_{SW}=5.2V$ $V_{SW}=0V$			10	μA
NMOS Switch Curret Limit			1.3		A
start-up Current Limit			1.3		A
Short-Circuit Hiccup time	ON		2		ms
	OFF		80		ms
EN Input Current	$V_{EN}=5V$ or 0V	-1	0	1	μA
EN High Voltage	$V_{OUT}=5V$	1.2			V
EN low Voltage	$V_{OUT}=0V$			0.4	V
Thermal Shutdown	Rising, Hysteresis= $25^\circ C$		160		$^\circ C$

TYPICAL PERFORMANCE CHARACTERISTICS ($T_A=25^\circ\text{C}$ unless otherwise specified)

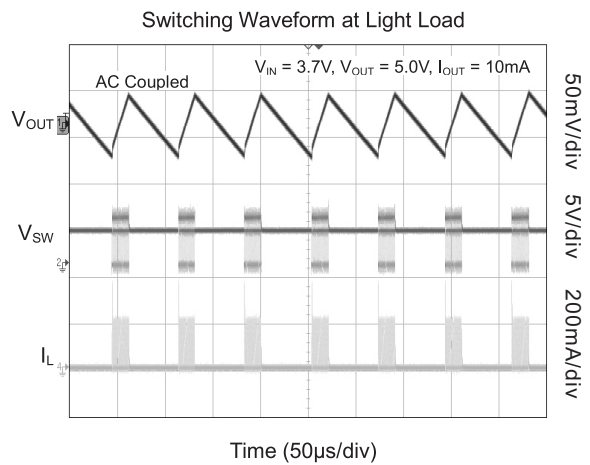
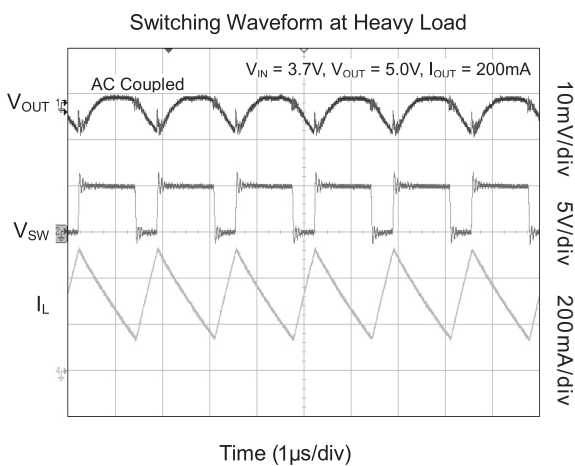
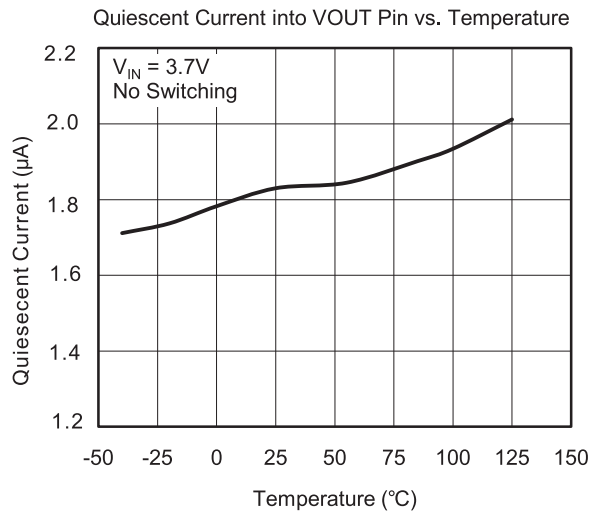
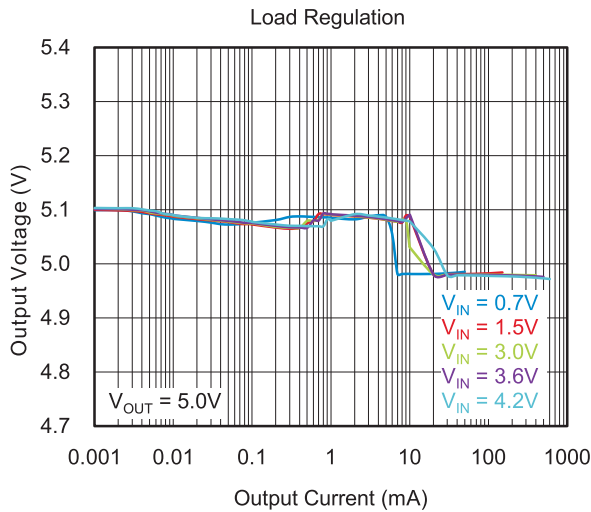
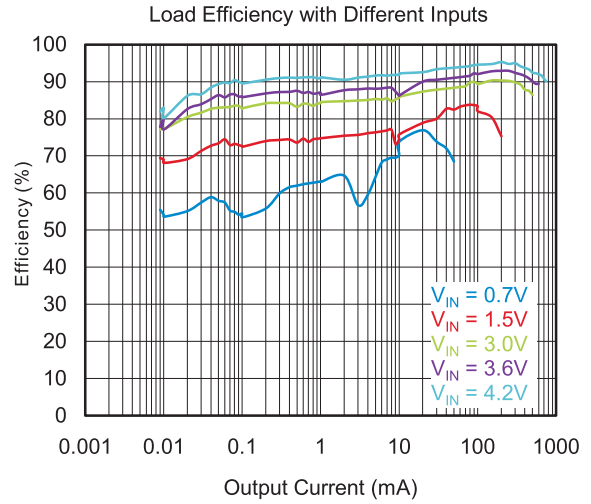
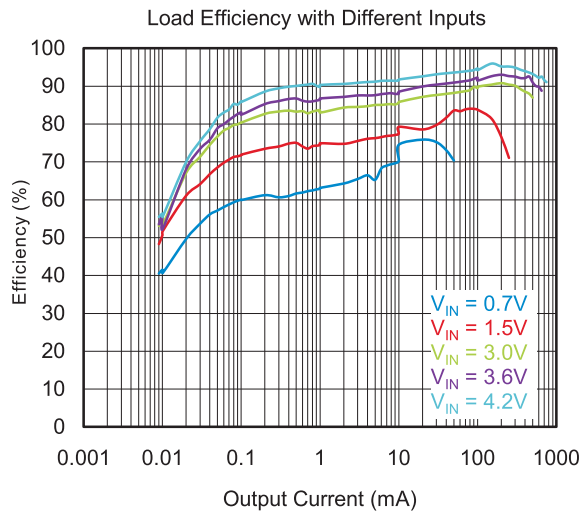

(1) Not tested in production. Specified by design.

Startup by VIN Pin

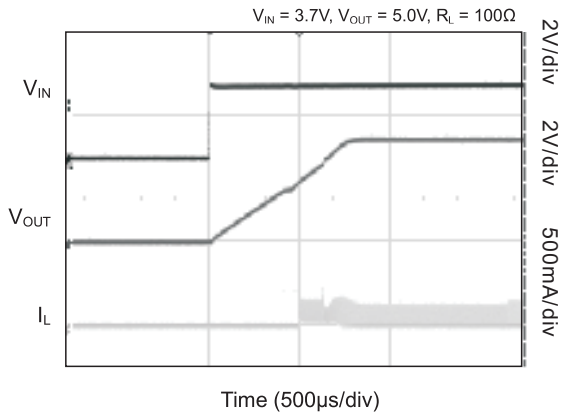

Startup by EN Pin

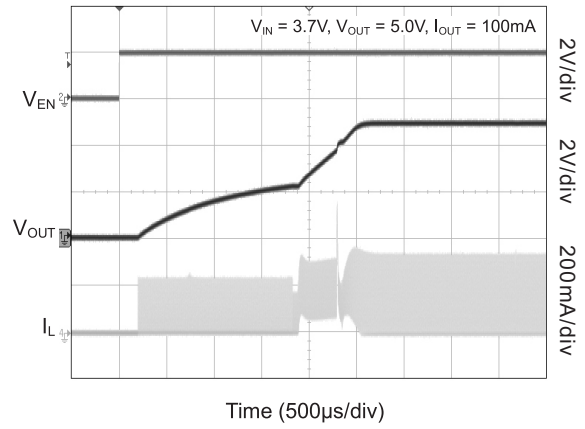

Line Transient Response

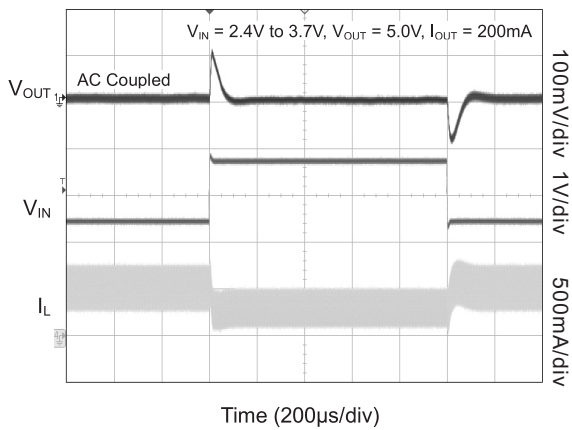

Load Transient Response

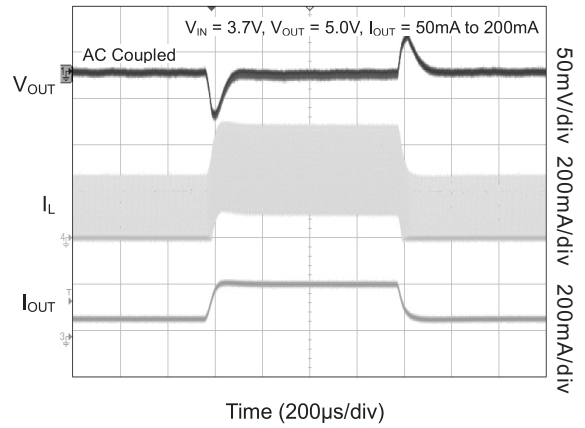

Current Limit vs. Temperature

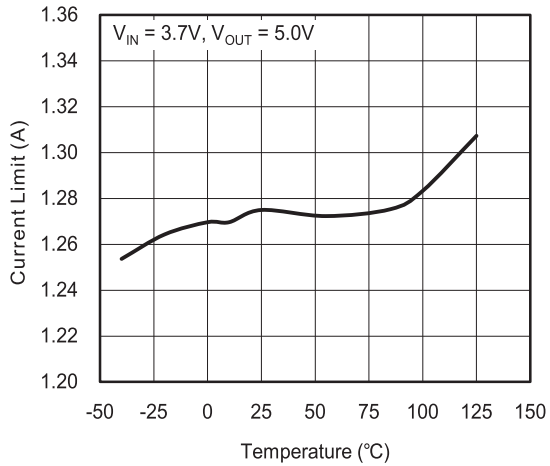

APPLICATION INFORMATION

Loop Operation

CS5010S is a high efficiency synchronous step-up converter with ultra-low quiescent current down to 2μA. It integrates a 220mΩ low side main MOSFET and 160mΩ synchronous MOSFET. It uses a PWM current-mode control scheme. An error amplifier integrates error between the FB signal and the internal reference voltage. The output of the integrator is then compared to the sum of a current-sense signal and the slope compensation ramp. This operation generates a PWM signal that modulates the duty cycle of the power MOSFETs to achieve regulation for output voltage. The peak current of the NMOS switch is also sensed to limit the maximum current flowing through the switch and inductor. The typical peak current limit is set to 1.3A. An internal temperature sensor prevents the device from getting overheated in case of excessive power dissipation.

Ultra low current consumption at light load operation

Traditionally, a fixed constant frequency PWM DC/DC regulator always switches even when the output load is small. When energy is shuffling back and forth through the power MOSFET, power is lost due to the finite RDSONs of the MOSFETs and parasitic capacitances. At light load, this loss is prominent and efficiency is therefore very low. CS5010S employs a proprietary control scheme that improves efficiency in this situation by enabling the device into a power saving mode during light load and the no load quiescent current can be as low as 2μA.

Short-Circuit Protection

Unlike most step-up converters, the CS5010S allows for short circuit on the output. In the event of a short circuit, the device first turns off the NMOS when the sensed current reaches the current limit. When OUT drops below IN, the device then enters a linear charge period with the current limited same as with the start-up period. In addition, the thermal shutdown circuits disable switching if the die temperature rises above 160°C.

Adjustable Output Voltage Setting with FB pin

By adding a resistor divider at FB pin (R1 and R2 as shown in the circuit below), CS5010S can be set to any voltage level less than 5V at output node. But as there is already a large internal resistor (about 20MΩ) from FB to GND to set the fixed output voltage, the R2 is recommended to be 200K or less, which will add about 6μA or more at output. The output voltage is set by following equation:

$$V_{out} = \frac{R1+R2}{R2} \times 1.01V$$

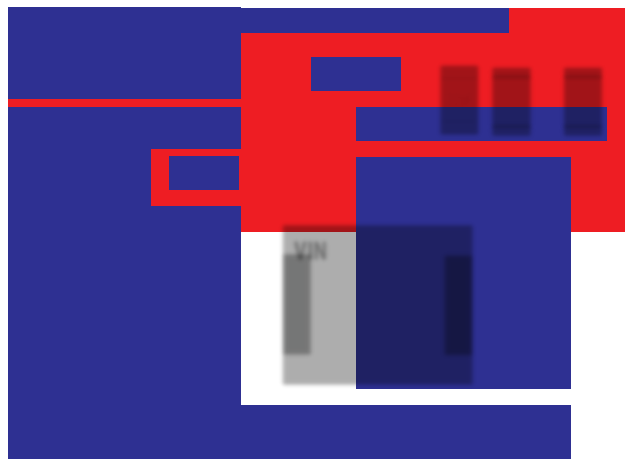

PACKAGE INFORMATION

SOT23-6L Package Outline & PCB Layout

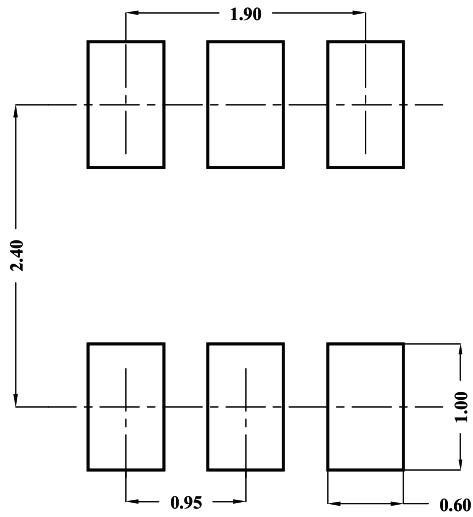

Recommended Pad Layout

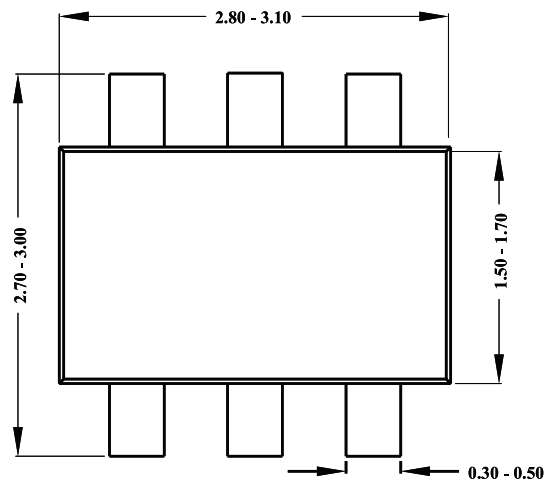

Top View

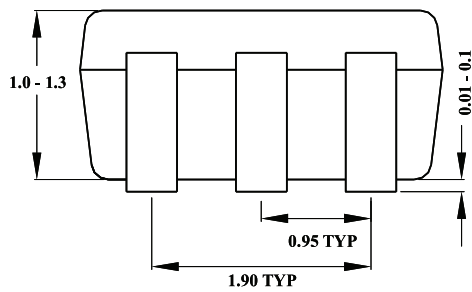
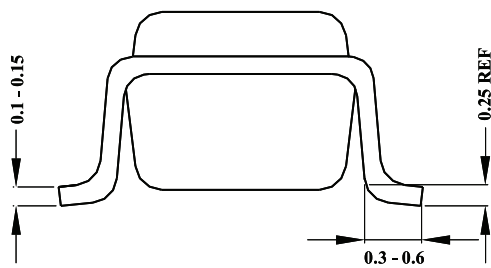

Notes: All dimension in MM
All dimension don't not include mold flash & metal burr